























Centrifuge 5804 / 5804 R / 5810 / 5810 R

Instruction Manual · Mode d'emploi succinct
Instrucciones breves

eppendorf

Centrifuge 5804 / 5804 R / 5810 / 5810 R

Shortcuts

Task / Function	Lid	Press	Display Centrifuge 5804 /R / 5810 /R	Chapter in instruction manual
Parameter set		1. Select  or  etc. 2. Select  or 	1. Selected parameter flashes. 2. New nominal value appears.	3.5 3.8
Soft start / stop		1. Press repeatedly  2. Select ramp  or 	Acceleration  ramp 9 (fast)... 0 (slow) Deceleration  ramp 9...0	3.11
Alarm ON / OFF		 + 	"alarm on" "alarm off"	3.19
Programming (only during standstill)		1. Set parameter 2. Press 2 x  3. Storing:  > 2 sec	1. Parameter shown 2. "P..." symbolizes first free program no. 3. "ok"	3.14
At set rpm		 > 4 sec	 on  off	3.12

Centrifuge 5804 / 5804 R / 5810 / 5810 R

Figure 1 + 2

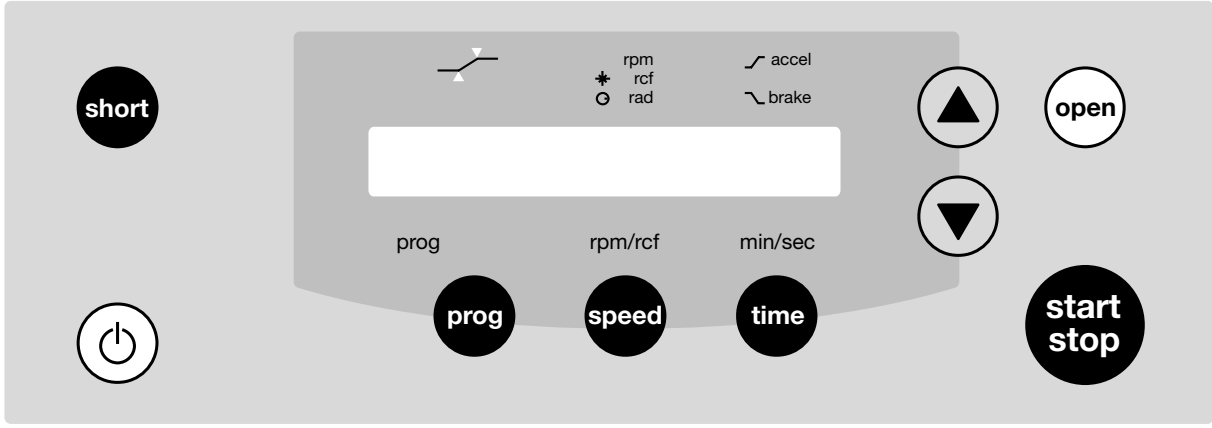

Fig. 1: Display field and control panel of the 5804 / 5810 (non-refrigerated)

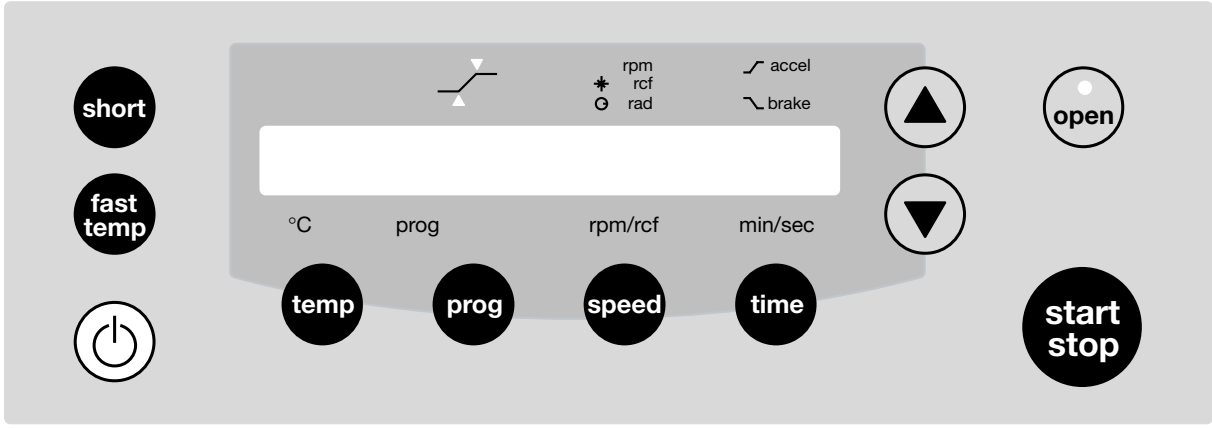

Fig. 2: Display field and control panel of the 5804 R / 5810 R (refrigerated)

Centrifuge 5804 / 5804 R / 5810 / 5810 R

Centrifuge 5804 / 5804 R / 5810 / 5810 R

Operating Instructions	5
Mode d'emploi succinct	26
Instrucciones breves	32

No part of this publication may be reproduced without the prior permission of the copyright owner.

Copyright© 2005 Eppendorf AG, Hamburg

Centrifuge 5804 / 5804 R / 5810 / 5810 R

Contents

1	Introduction	6
1.1	Delivery package	6
1.2	Unpack	6
1.3	Installing the device	6
2	Safety regulations and applicational limitations	8
3	Operating	10
3.1	Operating controls	10
3.2	Mounting / dismounting the rotors	10
3.3	Rotor lid F-45-30-11	10
3.4	Loading the rotors	10
3.5	Routine centrifugation with preset time / rcf display	12
3.6	Continuous operation	13
3.7	Short spin centrifugation (Short spin)	13
3.8	Time change during the run	14
3.9	Refrigeration (for 5804 R/ 5810 R only)	14
3.10	Preset radius	15
3.11	Centrifugation with Soft start / stop	15
3.12	At set rpm	15
3.13	Preset program	15
3.14	Programming	16
3.15	Write protection	16
3.16	Nominal value display	16
3.17	Automatic rotor recognition	16
3.18	Display of elapsed spin time	17
3.19	Switching on/off the warning signal	17
3.20	Exiting the Service program	17
3.21	Control via serial interface (optional)	17
3.22	Opening the centrifuge in the case of a power failure	17
3.23	Overload cutout switch / Fuses	17
4	Maintenance and cleaning	18
4.1	Device	18
4.2	The rotors	18
4.3	The aerosol-tight rotor	18
4.4	Rotor sterilization	18
4.5	Glass breakage	19
4.6	Refrigerated centrifuges	19
4.7	Return of devices	19
5	Troubleshooting	20
6	Technical data	21
7	Ordering information	22

1 Introduction

The Centrifuges 5804 / 5810 are non-refrigerated bench-top centrifuges and the Centrifuges 5804 R / 5810 R are refrigerated bench-top centrifuges. The 5804 / 5804 R models have a maximum capacity of 400 ml and the 5810 / 5810 R models have a maximum capacity of 1600 ml. All centrifuges are intended for use in research and routine laboratories in the biosciences and in the fields of medicine and research.



This sign is found on your centrifuge and on several pages in the operating manual. Texts labeled with this sign contain safety notes. Read these safety precautions before using the centrifuge for the first time.

Before starting up the Centrifuges 5804 / 5810 and 5804 R / 5810 R for the first time, please read the instruction manual.

1.1 Delivery package

- 1 Centrifuge 5804 / 5810 with fan cooling or 1 refrigerated Centrifuge 5804 R / 5810 R (rotor not included with centrifuges)
- 1 Main power cable (European standard plug)
- 1 Instruction manual
- 1 Rotor key

1.2 Unpack

When the machines are removed from the packaging, they must be supported by two persons near the rubber feet at the bottom on the left- and right-hand side and then carried the short distance to the lab bench. Please observe the weight-bearing capacity of the bench. If the machines are to be transported over long distances in the lab, a trolley must be used.

1.3 Installing the device



For 5804 R and 5810 R only: To avoid damage to the compressor caused by incorrect transportation, wait four hours after installation before switching on the device.

To disconnect the centrifuge from the power supply in the event of an error, an emergency switch must be installed away from the centrifuge, preferably outside the centrifugation room or next to the exit of this room.

- Place the centrifuge onto a horizontal, **stable and resonance-free** work surface.
- Ensure that the working environment is well-ventilated and not exposed to direct sunlight.
- There should be 15 cm clearance at the sides of the centrifuge and 10 cm to the rear.
- According to the regulations of the EN 61010-2-020 standard, a safety distance of 30 cm must be observed around the centrifuge during operation. No objects which cause damage when destroyed must be positioned in this space.
- Before plugging in the centrifuge, compare your power supply with the electrical requirements listed on the identification plate.
The mains cable of the centrifuge may be connected only to a socket with a protective conductor.
- On refrigerated centrifuges 5804 R and 5810 R with a mains voltage of 120 V, a distinction is made between two versions depending on requirements: the 15 A variant is equipped with a conventional IEC power cable (see Fig. 3) so that these devices can be operated directly at the lab work-station using a conventional socket (120 V, 15 A). However, this causes a drop in the cooling performance of this kind of device. This technical specification leads to a rise in the lowest temperature which can be reached at maximum speed and to slower cooling down to the specified value.

1 Introduction



Fig. 3: 15 A IEC power cable

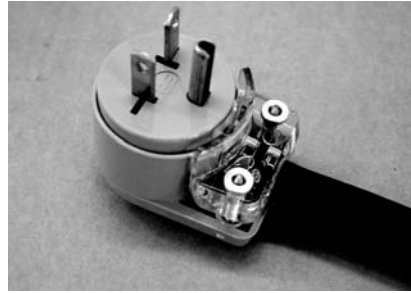

Fig. 4: 20 A standard variant

On the 20 A standard variant, by contrast, the power cable is permanently attached to the device (see Fig. 4). These devices have a special 20 A plug and require the appropriate socket to guarantee the supply of current and voltage required for the centrifuges (120 V, 20 A). The advantage is greater, more rapid cooling.

- To switch on the centrifuge, press the mains switch (on the right-hand side of the device). The nominal values of the test run appear in the display and the control lamp in the **Open** key lights up.
- The centrifuge lid can be opened by pressing the **Open** key.

Please insert the rotor before starting and tighten it with the supplied rotor key.

The rotors A-4-81 and A-4-81-MTP are tightened with the special rotor key included in the rotor delivery package.

2 Safety regulations and applicational limitations

In the interests of your own personal safety, always observe the following regulations:



The rotor and the rotor cover must always be securely fastened.

Do not begin centrifugation before the rotor has been securely fastened.

The rotor must be loaded symmetrically. Opposing tubes should be of the same type and should be filled equally.

For reasons of mechanical stabilization, **all** positions of rotor A-4-44 and A-4-62 / A-4-62-MTP must be loaded with buckets of the same type.

Prior to centrifugation, the tubes should in any case be visually inspected for material damage. Damaged tubes may not be centrifuged. This is because broken tubes can, in addition to sample loss, result in further damage to the centrifuge and accessories.

Do not use buckets and rotors which show clear signs of corrosion or mechanical defects. Please check accessories at regular intervals.

Do not operate centrifuges which have not been correctly installed or repaired.

Do not move or knock against the centrifuge during operation.

Repairs must only be performed by an Eppendorf authorized service technician.

Only use original rotors and spare parts recommended by Eppendorf.

The Centrifuges 5804 / 5810 and 5804 R / 5810 R may only be used for special applications. They must not be operated in a hazardous or flammable environment and must not be used to centrifuge explosive or highly reactive substances.

If such liquids are spilled in the rotor or rotor chamber, the centrifuge must be cleaned with a moist cloth and a mild soap solution.

A liquid density of 1.2 g/ccm must not be exceeded at the maximum rotational speed.

During longer spin times in the 5804 / 5810 models, the sample tubes may heat up. Observe the limiting data specified by the tube manufacturer.

The use of organic solvents (e.g. chloroform) may have an adverse effect on the stability of plastic test tubes.

Following operation in a cooling room, run the centrifuge for 30 minutes in the cooling room until it is warm. Alternatively, allow it to warm up in a lab for at least three hours, but **do not plug in the centrifuge** in order to prevent damage caused by condensation.

Rotors are high-grade components which are subject to extreme mechanical strain. Aluminium rotors are protected against corrosion caused by commonly-used laboratory chemicals by means of an electrolytic coating, although this protection cannot be fully guaranteed.

Please ensure that the rotor is protected from mechanical damage. Even slight scratches and cracks can cause severe inner damage to the rotor materials, which are difficult or impossible to detect with the eye.

Please avoid using aggressive chemicals with the rotors. Such chemicals include concentrated and mild alkalis, concentrated acids, solutions containing mercury ions, copper ions and other heavy-metal ions, chlorinated hydrocarbons and concentrated saline solutions.

When handling toxic or radioactive liquids or pathogenic bacteria out of Risk Group II (see World Health Organization: "Laboratory Biosafety Manual"), observe national regulations.

In the event of contamination caused by impurities or aggressive agents, the rotor must be cleaned **immediately** using a neutral cleaning liquid. This is particularly important for the bores of the fixed-angle rotor and for the buckets.

Please clean your rotor regularly using a **neutral** cleaning liquid (e.g. Extran[®] neutral or RBS neutral). This will protect the rotor and prolong its service life.



According to EN 55011, the centrifuges 5804/5804 R and 5810/5810 R are Class A products. Interference with signal reception can occur in residential areas. The operator should take appropriate protective measures.

2 Safety regulations and applicational limitations

The following rotors and accompanying buckets have a maximum operating life of seven years. The date of production is engraved on the rotor in four-digit form (e.g. 10/98 = October 1998):

A-4-44	5804 730.003	A-4-62-MTP	5810 711.002
A-2-DWP	5804 740.009	T-60-11	5804 730.003
F-34-6-38	5804 727.002	A-4-81	5810 718.007
A-4-62	5810 709.008	A-4-81-MTP	5810 725.003

Transparent rotor lids made of PC and PP as well as the PC caps of the rectangular buckets have an operating life of three years. The date of production is engraved in the form of a clock .

Contact with organic solvents (e.g. phenol, chloroform) may have an adverse effect on the transparent (polycarbonate) caps of the aerosol-tight rotors. Please check lids of this type regularly for chemical damage or for cracks. Cracked caps or caps with a milky discoloration must be replaced immediately.



Do not use rotors, caps or buckets which have been subjected to chemical or mechanical damage or which have exceeded their maximum operating life!

* PC = Polycarbonate; PP = Polypropylene

3 Operating

3.1 Operating controls

See the fold-back cover at the front of this manual.

In the text,  ,  ,  , etc. signify keys

"Buckets" include buckets and titer plate buckets.

3.2 Mounting / dismounting the rotors

A summary of the various different rotors can be found in the brochure.

Clean the motor axle and the rotor bores with a cloth before attaching the rotor.

- When fastening / loosening the rotor onto / from the motor axle, ensure that the temperature of the rotor and the motor axle is between 10 °C and 30 °C.
- Mount the rotor onto the motor axle and tighten the rotor nut by turning clockwise using the appropriate rotor key supplied.
- To dismount the rotor, turn the rotor nut counterclockwise using the rotor key.
- When the rotors are not in the centrifuge, please place them in the rotor stand (Order no. 5804 720.008).
- Do not centrifuge using rotors and buckets with visible corrosion or mechanical defects (see Chapter 2: Safety regulations and applicational limitations).

The Centrifuges 5804 / 5810 and 5804 R / 5810 R have automatic rotational speed limitation.

3.3 Rotor lid F-45-30-11

The non-aerosol-tight rotor lid of the rotor F-45-30-11 is attached by pressing the lid onto the rotor. The rotor lid need not be screwed tight.

3.4 Loading the rotors

The rotors and buckets must always be loaded symmetrically. The adapters may only be loaded with the test tubes recommended.

Differences in the weight of the filled sample tubes should be kept as low as possible in order to prolong the life-time of the drive and to minimize running noises caused by imbalance.



On each rotor you will find information concerning the maximum weight of a completely loaded bucket (bucket including adapter, tubes and liquid or titer plate buckets including titer plate and liquid) (see also applicational limitations).

Performance data of the rotors

Type Designation	max. capacity (ml)	max. rotational speed rpm / max. rcf (x g)	max. Radius (cm)	5804 / 5804 R	5810 / 5810 R	Aerosol-tight centrifugation possible
Swing-bucket rotors						
A-4-81 ¹⁾	4 x 400 ml	4,000 / 3,250	18.0	–	●	●
A-4-81 ^{1) 3)}	96 x 2 ml	4,000 / 2,600	14.6	–	●	–
A-4-81-MTP ¹⁾	16 x MTP-Platte	4,000 / 2,900	15.3	–	●	–
A-4-62 ²⁾	4 x 250 ml	4,000 / 3,200	18.0	–	●	●
A-4-62-MTP ²⁾	16 x MTP-Platte	4,000 / 2,750	15.4	–	●	–
A-4-44	4 x 100 ml	5,000 / 4,500	16.1	●	●	●
A-2-DWP	4 x Deepwell-Platte	3,700 / 2,250	14.7	●	●	–
Fixed-angle rotors						
F-34-6-38	6 x 85 ml	11,000 / 15,550	11.5	●	●	–
F-34-6-38	6 x 85 ml	12,000 / 18,500	11.5	–	only 5810 R	–
F-45-30-11	30 x 2 ml	14,000 / 20,800	9.5	●	●	–
FA-45-30-11	30 x 2 ml	14,000 / 20,800	9.5	●	●	●
F-45-48-PCR	6 x 8er PCR-Streifen	12,000 / 15,350	9.5	●	●	–
Drum rotor						
T-60-11	60 x 2 ml	14,000 / 16,400	7.5	●	●	–

3 Operating



- 1) The swing-bucket rotor can be delivered without buckets, equipped with rectangular buckets as an A-4-81 or with MTP buckets as an A-4-81-MTP, whereby the flex buckets (especially MTP-buckets) can be purchased extra in sets of 2 or 4, user-friendly change of rectangular buckets or MTP and flex buckets is guaranteed by the use of a common rotor cross.
- 2) The swing-bucket rotor can be delivered as A-4-62 (loaded with buckets) or as A-4-62-MTP (loaded with microtest plates). User-friendly exchange of rectangular buckets or microtest plate buckets is guaranteed by the use of all-in-one rotor cross.
- 3) A-4-81 is equipped with flex buckets and IsoRack adapters.

Swing-bucket rotor



Only the combinations of rotor/buckets/adaptor which are recommended by the manufacturer may be used.

Please check whether all buckets have been **inserted correctly** and can swing freely.

For purposes of mechanical stabilization, **all** positions of the rotors A-4-44 and A4-62 / A-4-62-MTP must be loaded with the same buckets. In contrast, the rotor A-4-81 / A-4-81-MTP can be equipped with a mix of rectangular buckets and titer plate buckets. It is in principle not permitted to use swing-bucket rotors with only two rectangular buckets or titer plate buckets inserted.

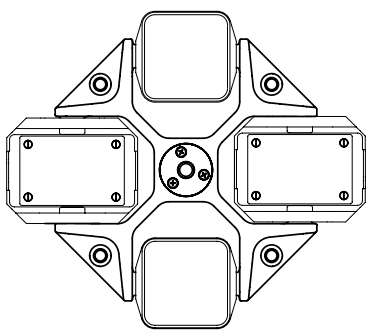

Fig. 5: Rotor A-4-81-MTP symmetrically loaded

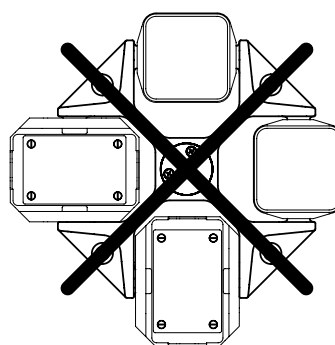

Fig. 6: Not allowed, because the pegs are not evenly loaded, rotor is asymmetrically loaded

The rectangular buckets are sorted according to weight. The weight category is printed on the side in the groove: e.g. 86 (the last two places in grammes). Opposing buckets should be of the same weight category. When placing follow-up orders, please state the weight category. This also applies to titer plate buckets.

Ensure that the grooves are clean before inserting the buckets. Unclean grooves and pivots prevent the buckets from swinging freely.

When working with a rotor which is not completely loaded, position the tubes within the buckets in such a way that the rotor pivots are stressed evenly.

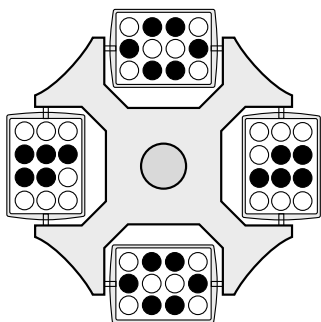

Fig. 7: Rotor is symmetrically loaded

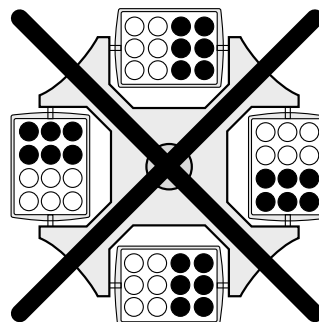

Fig. 8: Not permitted: pivots are not stressed evenly, rotor is not symmetrically loaded



A manual swing test with empty tubes must be carried out if oversized tubes (i.e. longer than 100 mm) are used.

3 Operating

Permitted loads for the swing-bucket rotor

Rotor	A-4-44 (4 x 100 ml)	A-2-DWP (Deepwell- plate rotor)	A-4-62 (4 x 250 ml) A-4-62-MTP	A-4-81 (4 x 400 ml) A-4-81-MTP
Maximum load per 100 ml rectangular bucket	310 g (adapter + tubes)	—	630 g (adapter + tubes)	780 g (adapter + tubes)
Maximum load per plate carrier	—	380 g (with full plates)	380 g (with full plates)	380 g (with full plates)
Maximum load per 50 ml Falcon® bucket	144 g (for two conical tubes incl. liquid and form insert)	—	—	—
Specifications on the rotor (weight for loaded buckets / rectangular buckets)	4 x 0.6 kg	2 x 1.010 kg	4 x 1.1 kg	4 x 1.4 kg (A-4-81) 4 x 1.22 kg (A-4-81-MTP)

The weight specifications printed on the rotor (e.g. 4 x 0.6 kg for the 4 x 100 ml swing-bucket rotor A-4-44) correspond to the overall weight of the rectangular bucket, inclusive of adapter, test tubes and the contents of each individual position.

In general, commercially-available deepwell plates with a 96-well plate format may only be used in the buckets of the A-4-62-MTP on condition that the **maximum load** does not exceed **380 g** and the **maximum height** of the plate does not exceed **53 mm**. This restriction also applies to stacked titer plates or culture plates.

Commercially available deepwell plates or filter plates / filter plate stacks in the 96-well plate format may be inserted in the buckets of the A-2-DWP only if their **load does not exceed 380 g** and their **height does not exceed 89 mm**. These restrictions also apply to stacked titer plates or culture plates.

Commercially available deepwell plates or filter plates / filter plate stacks may be inserted in the buckets of the A-4-81-MTP only if their **load does not exceed 380 g** and their **height does not exceed 60 mm**. These restrictions also apply to stacked titer plates or culture plates.

If deepwell plates used with dimensions which do not correspond to the values stated above (e.g. prototypes, combination plates with a heavy lid or specially designed plates), the user must consult Eppendorf to establish the suitability of using these plates in a titer plate or Deepwell plate rotor.

Under no circumstances use MTP-, MTP / Flex- and DWP-buckets with deformed side plates.

3.5 Routine centrifugation with preset time / rcf display

Turn on the main power switch. The nominal values of the last run are displayed.

Load the rotor symmetrically and close the centrifuge lid. The **Open** key lights blue.



activates the preset speed. The SPEED display flashes.



modify the values. The new nominal value appears in the display.



If the preset speed is in rcf, please check the radius that has been entered. (see Section 3.10).

3 Operating



to select rcf, press this key repeatedly until the rcf symbol (✱) appears to the left of the SPEED display. The rcf value flashes and can be modified using the **arrow** keys.



activates the preset time. The TIME display flashes. The time can be modified using the **arrow** keys.



activates the preset temperature. The nominal temperature in °C can be modified using the **arrow** keys.



starts the run. ■ flashes and displays the rotation of the rotor.

Rotor recognition (see also Chapter 3.16) occurs at 200 to 700 1/min and the device then accelerates to the nominal speed.

During the run, the rotational speed of the rotor or the appropriate rcf value, the sample temperature and the remaining spin time in minutes are displayed. The last minute is counted down in seconds. During the run, all parameters can be modified.

After the end of a run, or after a run has been interrupted by pressing the **Stop** key, the rotor is braked and brought to a standstill. During the braking process, the time display flashes and the elapsed spin time is displayed.

When the lamp in the **Open** key lights up, the lid can be unlocked by pressing the key.

3.6 Continuous operation



The continuous operation function is set above 99 min or below 1 min using the **arrow** keys. In the time display, "oo" indicates continuous operation. During the run, the actual rotational speed/ RCF and temperature values and the elapsed time in minutes are displayed. If the centrifuge runs for more than 99 min, "99." appears in the display. The run is ended with the **STOP** key.

3.7 Short spin centrifugation (Short spin)



Press for as long as the run should last. The text "SH" will appear in the display. The elapsed time is displayed in seconds. An already interrupted run can be continued up to two times by repeatedly pressing the key, as long as the centrifuge has not yet come to a stillstand.

If the Short key is pressed while the lid is open, one of the following two status signs will appear, depending upon the rotor recognized (see Chapter 3.16 Automatic rotor recognition): "rpm max" or "200 – rpm"

The status displays mean:

"rpm max": The inserted rotor accelerates to its nominal rotational speed.

"200 – rpm": The maximum rotational speed for the short-spin run can be set over the arrow keys.

If the Short key is pressed for longer than three seconds while the centrifuge lid is open, the device will switch over to the other status and display it for two seconds. The status set last will be maintained.

3 Operating

3.8 Time change during the run



Press this key during the run (not during the braking phase).



change the duration of the run. The time elapsed is taken into account in the new actual value.



3.9 Refrigeration (for 5804 R / 5810 R only)



The nominal temperature value can be set from -9 °C to $+40\text{ °C}$. It can be modified during centrifugation.



Once the nominal temperature value has been reached, a deviation greater than $\pm 3\text{ °C}$ is indicated by a flashing temperature display.



If the temperature deviates by more than 5 °C , a periodic warning signal can be heard and the centrifuge switches itself off.



starts a temperature run at a rotor-specific speed for the best possible refrigeration. The new preselected temperature is quickly attained **in the rotor** by cooling. **FT** appears in the PROG field. The run is then ended automatically at the arrived at nominal temperature or by pressing the **Stop** key. A signal can be heard at regular intervals.

The centrifuge does not terminate the run until the rotor, carrier or rectangular bucket have reached the pre-selected temperature. The target temperature is initially measured on the chamber and then shown in the display. However, the temperature run is automatically terminated when the rotor, carrier or rectangular bucket have reached the target temperature.

Standby-refrigeration

When the lid is closed, the rotor chamber is refrigerated to the preselected nominal temperature before or after a run, as long as this value is below ambient temperature. The rotor does not turn during this procedure and the temperature changes more slowly.

If the centrifuge is not used for longer than 8 hours, or if the lid is not opened for this time, the refrigeration function switches off for safety reasons. **Standby off** appears in the display, together with the nominal temperature in the rotor chamber. The desired temperature can be reached rapidly via the **Fast Temp** function.

The standby cooling of the centrifuge can also be switched on permanently. To do this the **Temp** and **Prog** keys must be pressed simultaneously. **Standby 8h** appears in the display. Following this, the **Fast temp** must be pressed immediately in order to switch the standby cooling over into permanent operation. **Standby endless** appears in the display.



The standby cooling is automatically switched off after 8 hours in order to protect the device. The switching of standby cooling to permanent operation is carried out at own risk and can lead to overheating of the compressor.

Please empty and clean the tray for condensation water (on the right at the bottom of the device) on a regular basis.



Remove any condensation water and ice regularly from the rotor chamber using a soft, moist cloth. Defrosting is recommended for ice removal.

3 Operating

3.10 Preset radius

The internal conversion of rotational speed to RCF occurs as a standard with the largest radius. A smaller radius can be entered for another adapter.



Press this key repeatedly until the radius symbol (⊙) appears to the left of the SPEED display. The radius value flashes.



change the values entered. The new rcf value appears three seconds (or 10 s during the stillstand) after the rotor radius has been entered.



3.11 Centrifugation with Soft start / stop

If the maximum acceleration / deceleration speed (level 9) is not desired, it is possible to set the speeds in nine different levels.



Press this key repeatedly until  (the symbol for the acceleration levels) appears next to the TIME display



Presetting the acceleration level 9 – 0.

Deceleration is set in the same way .

Braking level 0 corresponds to free deceleration.





For levels 0 – 8, the symbols   appear in the display.

3.12 At set rpm

The "at set rpm" function triggers a counting down of the centrifugation time upon achieving the preselected rotational speed ("at set rpm").

Pressing the START / STOP key for longer than 4 seconds while the centrifuge lid is open triggers a switching over to the "at set rpm" function. While the key is pressed, both triangles of the pictogram are illuminated in blue in an alternating sequence.

The activated "at set rpm" function is symbolized by the continuously illuminated, upper blue triangle in the pictogram .

In order to leave the "at set rpm" function again, and thus to activate the countdown of the centrifugation time directly after switching on the centrifuge, press the **START / STOP** key while the centrifuge lid is open. The standard setting is selected again after 4 seconds, symbolized by the illumination of the lower triangle in the pictogram .

3.13 Preset program

Programs can only be preselected when the device is at a standstill.



Press this key **once** → the program no. that has been set flashes.

0 Data from last run.

1...9, A...Z Fixed programs.



select further program numbers.



Returns to program 0 or leaves the programming mode when the lid is open.

In order to start the selected program immediately, the centrifuge lid must be closed prior to pressing the **START / STOP** key.

3 Operating

3.14 Programming

Storing a fixed program (only possible when the device is at a standstill):

It is possible to save a maximum of 35 fixed programs (1...9, A...Z).

Enter the program data to be used first by pressing the parameter keys and the arrow keys or use the data from the last run. The "at set rpm" functions and the set deceleration ramp can also be saved in a program if necessary.



Press this key **twice** → the first free program no., indicated by "P..", appears in the display and flashes.



The desired free program number (1...9, A...Z) can be selected.



Hold down this key for **two seconds** until **ok** appears in the display. The previously set parameters of Temp., Speed, Time, etc. are now saved as a data set.

If parameters are modified during the run with a fixed program, "0" appears in the PROG field and the user exits the program without it being modified.

To exit the fixed program, call up program "0" or modify the parameters.

3.15 Write protection

In order to avoid accidental deletion of an existing fixed program, the old data set must be deleted while the lid is open prior to renewed assignment of a program number:



Press this key once → the program no. display flashes.



select the program no. which is to be deleted.



Press this key within ten seconds until **cleared** appears.

3.16 Nominal value display

All nominal values are displayed when the centrifuge is at a standstill. During a run, all nominal values can be displayed for 2.5 seconds by pressing one of the parameter keys (**Temp, Speed, Time**).

3.17 Automatic rotor recognition

Automatic rotor recognition occurs at the beginning of each run.

When a new rotor is recognized, the maximum rotational speed appears in the display for two seconds.

If the nominal speed set is greater than the maximum speed for the rotor used, it is aligned to the maximum speed and the run is interrupted. SPEED appears in the display and the run must be restarted.

The rotational speed and the radius for the rcf value will be reset to the maximum permitted value.

If a run with a program has been started, the program number is set to "0".

3 Operating

3.18 Display of elapsed spin time



If the **Time** key and the **Prog** key are pressed simultaneously, the total running time (in hours) of the centrifuge appears in the display. This function can only be selected when the rotor is at a standstill.

3.19 Switching on/off the warning signal



Press the **Speed** and **Time** keys simultaneously. "Alarm on" and "Alarm off" appear after 2 seconds alternately in the display.

3.20 Exiting the Service program



If the Service program has been selected accidentally, press both arrow keys simultaneously.

3.21 Control via serial interface (optional)

All centrifuge functions can be operated via the serial interface (RS 232). The appropriate conversion must be carried out by the service department.

Only devices which have been tested in accordance with IEC 950 may be connected via the serial interface.

3.22 Opening the centrifuge in the case of a power failure

If the magnetic lid latch cannot be activated because of a power failure, the emergency lid release can be activated manually:



Turn off the main power switch. Wait until the rotor has come to a standstill (The rotor may continue spinning for up to eight minutes). Insert the standard rotor key into the opening in the middle of the front part in the nut underneath and turn counter-clockwise. This disengages the lid, allowing it to be opened.

Be **absolutely** sure to remove the rotor key afterwards.

3.23 Overload cutout switch / Fuses

The 230 V and 120 V devices have built-in thermal overload switches which function as all-pole fuses. When the overload protection is actuated, these switches over the power switch to **OFF**, but do not switch it on again automatically.

To turn on the overcurrent protector switch again, please turn off the centrifuge for 10 seconds with the mains power switch. When the centrifuge is subsequently turned on again, the overcurrent protector switch will be automatically reactivated.

4 Maintenance and cleaning

4.1 Device



The outside of the centrifuge and the rotor chamber should be cleaned regularly with neutral detergent. This is for hygiene purposes as well as to prevent contamination caused by residual contamination.

The user is responsible for cleaning or decontaminating the centrifuge in the event of contamination caused by high-risk substances.

Open the lid of the centrifuge and disconnect the main power plug. Unscrew the rotor with the rotor key provided and clean separately. Only **neutral** agents may be used for cleaning and disinfection (e.g. diluted Extran[®] **neutral**, RBS **neutral** or 70 % isopropanol/water mixture or an alcohol-based disinfectant). The rotor chamber should only be cleaned with a moist cloth.

After cleaning with detergent, the rubber seals in the rotor chamber should be rinsed **well with water** and lubricated with glycerine in order to prevent the seals from becoming brittle.

If condensation water forms in the rotor chamber after freezing occurs, dry with a soft absorbent cloth.

The user must consult the manufacturer before cleaning or decontaminating the centrifuge using methods not recommended by the manufacturer in order to ensure that the centrifuge and accessories are not damaged. To ensure that the centrifuge functions correctly and safely in the long-term, please note that aggressive chemicals can damage the rotor, buckets and boiler. Please check the centrifuge regularly for damage caused by corrosion.

4.2 The rotors

The rotor and buckets must be cleaned regularly to prevent contamination caused by residue. Check at least the rotor and housing **monthly** for residue and corrosion. This applies in particular to the rotor bores. Please clean your rotor using a neutral cleaning liquid. This will protect the rotor and prolong its service life. As a reminder, the message "clean rotor" appears in the display of the centrifuge three times after every 200 runs.

When using the swing-bucket rotor, ensure that the grooves in which the buckets are fitted are free of contamination. The buckets can be lubricated with the lubricant (grease for pivots) supplied, although care must be taken to ensure that the buckets can still swing freely.

4.3 The aerosol-tight rotor

The sealing rings of the aerosol-tight rotor FA-45-30-11 are subject to natural wear and tear and should be replaced regularly if damaged. To protect the rotor, please ensure that the sealing rings are maintained regularly.

When handling the rotor lid, please observe the specifications regarding the chemical resistance of the materials of construction.

The cover of the aerosol-tight rotor must not be fastened tightly during storage!

4.4 Rotor sterilization

All rotors are autoclavable (121 °C, 20 min).

After the rotor has been autoclaved ten times, the lids of the aerosol-tight buckets or rotors must be exchanged.

The aerosol-tight Rotor FA-45-30-11 and the lid can be autoclaved at 142 °C for 2 hours to destroy prions, but the aerosol-tight lid must be exchanged after each autoclaving.

4 Maintenance and cleaning

4.5 Glass breakage

When centrifuging glass tubes, please observe that high speeds/rcf's increase the risk of glass breakage. Please follow the manufacturer's instructions concerning the maximum speed/rcf of centrifuge tubes. In the event of glass breakage, carefully remove all splinters and all ground glass from the rotor, the buckets, the adapters and the rotor chamber. You may need to replace the rubber mats and adapters to prevent further damage.

Fine splinters of glass may otherwise scratch the surface of the rotors and buckets, reducing their resistance to chemicals. The air turbulences within the rotor chamber produce a very fine black powder of abraded metal. In addition to causing damage to the rotor chamber, rotor, buckets and adapters, the powder also contaminates the samples.

Check the rotor bores regularly for residues and damage.

4.6 Refrigerated centrifuges

Clean the refrigeration mesh of the heat exchanger (on the rear side of the device) with a brush at least twice a year. Be sure to first switch off the centrifuge and pull the plug.

Switch off the centrifuge after use, leave the lid open and empty the tray for condensation water, situated below the device on the front right-hand side.

4.7 Return of devices

When returning centrifuges, please ensure that the devices have been decontaminated and thereby do not present a health risk to our Service staff.

You will find additional information and a blank of the decontamination confirmation at www.eppendorf.com. Do also consult your laboratory safety officer about a suitable decontamination method.

Please fill out the decontamination confirmation and place it together with the device when it is to be sent back to Eppendorf.

5 Troubleshooting

5

Troubleshooting

Centrifuges 5804 / 5810 and 5804 R / 5810 R

Error	Display	Cause	Solution
No display.	None	No main power connection. Power failure.	Check power supply cable. Check main power fuse on the device and in the laboratory.
	clean rotor Standby off	200 runs. Centrifuge not used for 8 hours.	Clean rotor and drum. Open lid and then close it again.
Centrifuge does not start up.	no rotor	No rotor. Error in the drive or rotor recognition.	Mount rotor. Switch off the device and switch it on again.
Lid cannot be opened.	None	Power failure.	Bring rotor to a standstill, activate emergency lid release.
Lid not closed completely.	Press Open Close Lid	Lid latch not engaged. Lid not closed correctly.	Press Open and close lid again. Press down lid.
Lid does not open.	Lift Lid	Lid does not open automatically.	Open lid manually.
Centrifuge shakes during acceleration and switches off.	IMBAL ROTOR	Rotor not loaded symmetrically.	Check rotor equipment and rotor load.
		Rotor not fastened.	Fasten rotor correctly.
Centrifuge switches off.	SPEED	Nominal speed for rotor too high.	Enter new nominal speed.
	Error 1	Rotor is not recognized. Problem with the rotational speed measuring system.	Repeat run. If error recurs, test with another rotor.
	Error 2	Imbalance sensor damaged.	Repeat run.
	Error 3	Problem with the rotational speed measuring system.	Leave device switched on for 8 min, press Open , then open the device. Repeat run.
	Error 4	Lid latch sensor damaged.	Switch device off and then switch it on again. Repeat run.
	Error 5	Unauthorized opening of lid or lid switch damaged.	Repeat run.
	overload or Error 6	Converter overloaded. Brake defective.	Allow to cool. Restart device after 5 min.
		Voltage supply too low. Rotor becomes loose.	Check voltage supply. Tighten rotor.
Error 7	Overspeed.	Repeat run.	
Error 8	Rotor loose. Drive error. Motor defective.	Tighten rotor.	
Centrifuge switches off. Warning signal.	overtemp	Temperature deviation from nominal value > 5°C.	Repeat run.
	Error 9–25	Electronics error.	
	Clear Memory	Program memory full.	Delete several programs or press Start or Prog to begin new run.
	Interrupt	Power failure during the run.	Restart.
Flashing temperature display.		Temperature deviation from nominal value > 3 °C.	

If the above solutions are unsuccessful, please contact SERVICE.

6 Technical data

6

Technical data

Centrifuges	5804 / 5804 R	5810 / 5810 R
Power supply:	230 V / 50 or 60 Hz	230 V / 50 or 60 Hz
Maximum power requirement: 5804 / 5810 5804 R / 5810 R	900 W 1650 W	900 W 1650 W
Fuse protection: 5804 / 5810 5804 R / 5810 R	Excess current switch 12 A Excess current switch 12 A	Excess current switch 12 A Excess current switch 12 A
Max. rotational speed:	14 000 rpm	14 000 rpm
Max. centrifugal force:	20 800 rcf	20 800 rcf
Max. kinetic energy: 5804 / 5810 5804 R / 5810 R	19 000 Nm (11 000 rpm) 19 000 Nm (11 000 rpm)	19 000 Nm (11 000 rpm) 23 000 Nm (12 000 rpm)
Max. load:	4 x 100 ml	4 x 400 ml
Max. density of material to be centrifuged:	1.2 g/ml	1.2 g/ml
Permitted ambient temperature during operation: 5804 / 5810 5804 R / 5810 R	2 °C to 40 °C 15 °C to 35 °C	2 °C to 40 °C 15 °C to 35 °C
Permitted maximum relative air humidity:	75 %	75 %
Degree of contamination	2	2
Overvoltage category	II	II
Standardized interface (optional)	RS 232 C	RS 232 C
Noise level	< 65 dB (A)	< 65 dB (A)
Dimensions (W x D x H): 5804 / 5810	466 x 496 x 337 mm (D = 550 with operating section)	535 x 536 x 345 mm (D = 608 with operating section)
5804 R / 5810 R	634 x 496 x 342 mm (D = 550 with operating section)	700 x 536 x 345 mm (D = 608 with operating section)
Weight: 5804 / 5810 5804 R / 5810 R	55 kg 80 kg	68 kg 99 kg
Electrical data for 120 V model		
Power supply:	120 V / 60 Hz	120 V / 60 Hz
Maximum power requirement: 5804 / 5810 5804 R / 5810 R, 20 A version 5804 R / 5810 R, 15 A version	950 W 1650 W 1300 W	950 W 1650 W 1300 W
Fuse projection in the device: 5804 / 5810 5804 R / 5810 R, 20 A version 5804 R / 5810 R, 15 A version	Excess current switch 12 A Excess current switch 18 A Excess current switch 15 A	Excess current switch 12 A Excess current switch 18 A Excess current switch 15 A

Technical specifications subject to change!

7 Ordering information

Centrifuge 5804

Bench-top centrifuge, max. capacity 4 x 100 mL with rotational speed regulation up to 14,000 rpm 120 V / 60 Hz, not including rotor	22622501
230 V / 50 – 60 Hz, not including rotor	22622552

Centrifuge 5804 R

Refrigerated bench-top centrifuge, max. capacity 4 x 100 mL with rotational speed regulation up to 14,000 rpm Temperature range: – 9 to 40 °C 120 V / 60 Hz, not including rotor	22623508
230 V / 50 – 60 Hz, not including rotor	22623559
Other voltages or 50 Hz frequency upon request.	

Captain Eppi , Rotor key holder, 1 piece	22639609
Captain Eppi , Rotor key holder, 10 pieces	22639625
Rotor stand, for all rotors for Centrifuges 5804 5804 R / and 5810 / 5810 R	22639021

Swing-bucket rotor and accessories (see brochure for further details) for Centrifuge 5804 / 5804 R

Swing-bucket rotor A-4-44 (4 x 100 mL), with 4 rectangular buckets of 100 mL	22637401
---	----------

1 rectangular bucket of 100 mL with weight category (for individual deliveries, please state the existing weight category)	22637410
---	----------

2 aerosol-tight caps for 100 mL rectangular bucket	22637428
--	----------

4 replacement seals for aerosol-tight caps of the rectangular bucket 100 mL	22637444
---	----------

Adapters for standard test tubes, blood withdrawal systems and micro test tubes
for 100 mL rectangular bucket
(Number and diameter of bores)

2 adapters for 3 – 5 mL test tubes (14 x 11)	22637509
--	----------

2 adapters for 1.5 – 2 mL micro test tubes (12 x 11)	22637525
--	----------

2 adapters for 4 – 7 mL test tubes (12 x 13)	22637541
--	----------

2 adapters for 3 – 15 mL test tubes (7 x 16)	22637568
--	----------

2 adapters for 7 – 17 mL test tubes (6 x 17.5)	22637584
--	----------

2 adapters for 7 – 18 mL test tubes (4 x 20)	22637622
--	----------

2 adapters for 12 – 30 mL test tubes (2 x 26)	22637649
---	----------

2 adapters for 30 – 50 mL test tubes (1 x 31)	22637681
---	----------

2 adapters for 50 – 75 mL test tubes (1 x 35)	22637703
---	----------

2 adapters for 80 – 120 mL test tubes (1 x 46)	22637720
--	----------

4 spare rubber mats	22662503
---------------------	----------

2 spare clamps	22662511
----------------	----------

Adapters for Falcon® test tubes for 100 mL rectangular bucket
(Number and diameter of bores)

2 adapters for 15 mL Falcon® test tubes (4 x 17.5)	22637606
--	----------

2 adapters for 50 mL Falcon® test tubes (1 x 31)	22637665
--	----------

4 buckets for 50 mL Falcon® test tubes (2 x 31)	22637452
---	----------

8 spare adapters for 50 ml Falcon® tubes as re-order	22637479
--	----------

Deepwell plate rotor A-2 DWP with 2 DWP buckets for deepwell plates	22638564
--	----------

Deepwell plate bucket with weight category for swing-bucket rotor A-2-DWP (individual delivery only as a replacement delivery with prior agreement)	22638572
--	----------

7 Ordering information

Fixed-angle rotors and accessories (see brochure) for the centrifuges 5804 / 5804 R 5810 / 5810 R

Fixed-angle rotor 6 x 85 mL, type F-34-6-38 with rotor lid	22637207
Spare lid for rotor F-34-6-38	22662961
2 adapters for micro test tubes (4 x 11.5)	22637215
2 adapters for 7 – 15 mL test tubes (2 x 16.5)	22637223
2 adapters for 15 – 18 mL test tubes (1 x 18.5)	22637231
2 adapters for 20 – 30 mL test tubes (1 x 26.5)	22637240
2 adapters for 50 mL test tubes (1 x 29)	22637258
2 adapters for 50 mL Falcon® test tubes (1 x 29.5)	22637266
2 adapters for 15 mL Falcon® test tubes (1 x 17)	22637274
Fixed-angle rotor 30 x 1.5 mL, type F-45-30-11 with rotor lid	22637002
Spare lid for rotor F-45-30-11	22662970
Fixed-angle rotor 30 x 1.5 mL, type FA-45-30-11 aerosol-tight, with rotor lid of aluminium	22637100
Spare lid for rotor FA-45-30-11	22637126
6 adapters for 0.4 mL centrifuge tubes	22636243
6 adapters for 0.5 mL micro test tubes and Microtainers®	22636227
6 adapters for 0.2 mL PCR-tubes	22636260
PCR-strip rotor F-45-48-PCR for 6 x 8-strips, 6 x 5-strips, 48 x 0.2 mL PCR-tubes	22638581

Drum rotor and accessories (see brochure) for the centrifuges 5804 / 5804 R 5810 / 5810 R

Drum rotor T-60-11 with rotor lid, for 60 x 1.5 mL / 2 mL tubes / 120 x 0.4 mL tubes with 6 adapters for 1.5 mL / 2 mL tubes	22638505
Adapter for 1.5 mL / 2 mL tubes (set of 6)	22638521
Adapter for 0.4 mL tubes (set of 6)	22638548

Accessories for the Centrifuges 5804 / 5804 R

Grease for pivots	22634330
Standard rotor key	22664166
Conversion kit for interface for 5804	Upon request
Conversion kit for interface for 5804 R	Upon request
Tray for condensation water	22662678

Important note:

Please use the original accessories recommended by Eppendorf. Using spare parts or disposables which we have not recommended can reduce the precision, accuracy and life of the centrifuges.

We do not honor any warranty or accept any responsibility for damage resulting from such action.

Rotor code

All Eppendorf rotors are designated according to a simple, logical system which describes the technical specifications as a uniform series of numbers and letters e.g.:

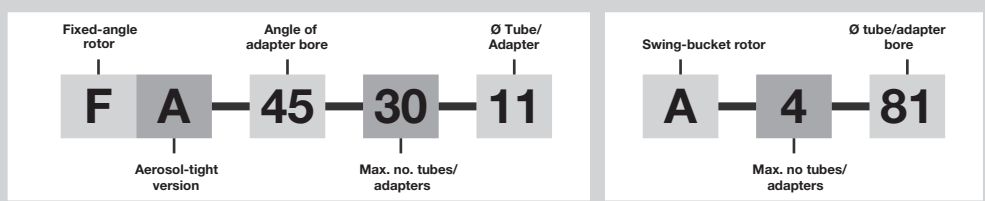

7 Ordering information

7

Ordering information

Centrifuge 5810

Bench-top centrifuge, max. capacity 4 x 400 mL with rotational speed regulation up to 14,000 rpm	
120 V / 60 Hz, not including rotor	22625004
230 V / 50 – 60 Hz, not including rotor	22625055

Centrifuge 5810 R

Refrigerated bench-top centrifuge, max. capacity 4 x 400 mL with rotational speed regulation up to 14,000 rpm	
Temperature range: –9 to 40 °C	
120 V / 60 Hz, not including rotor	22625501
230 V / 50 – 60 Hz, not including rotor	22625551
Other voltages or 60 Hz frequency upon request.	
Rotor stand, for all rotors for Centrifuges 5804 5804 R / and 5810 / 5810 R	22639021

Swing-bucket rotor and accessories (see brochure for further details) for Centrifuges 5810 / 5810 R

Swing-bucket rotor A-4-81 (4 x 400 mL) with 4 rectangular buckets of 400 mL	22638602
1 rectangular bucket of 400 mL with weight category (for individual deliveries, please state the existing weight category)	22638637
2 aerosol-tight caps for 400 mL rectangular bucket	22638661
Replacement cap sealings	22638670
Adapters for standard test tubes, Vacutainers® and Falcons® for 400 rectangular bucket:	
2 adapters for 2.6 – 7 mL (25 x 13, number and diameter of bores)	22638700
2 adapters for 5 mL (Monovette®; 18 x 13)	22638718
2 adapters for 7 – 17 mL (16 x 17.5)	22638726
2 adapters for 5 mL Falcon® (12 x 7.5)	22638742
2 adapters for 50 mL Falcon® (5 x 31)	22638769
2 adapters for 180 - 250 mL tubes (1 x 62)	22638921
2 adapters for 400 mL (1 x 81)	22638785
2 adapters for Centriprep®, Centrifugal Filter Units (5 x 31)	22638904
Replacement adapter rubber mats	22665201
Replacement adapter clamps	22638696
2 bottles 400 mL	22638653
Swing-bucket rotor A-4-81-MTP, with 4 MTP / Flex-buckets	22638807
4 MTP / Flex-buckets for swing-bucket rotor type A-4-81-MTP or A-4-81 for use of IsoRack adapters, cell culture flasks adapters and MTP, DWP	22638840
2 MTP / Flex-buckets	22638866
1 MTP / Flex-bucket	22638882
2 adapters for each cell culture flask for use in the MTP / Flex-buckets	22639005
2 adapters for each IsoRack for 0.5 ml micro test tubes	22638980
2 adapters for each IsoRack for 1.5 and 2.0 ml micro test tubes	22638998
1 IsoRack Starter Set: 2 IsoRack adapters, 2 IsoRacks with lid, 2 x 0 °C cool packs IsoRack; for 0.5 ml and 1.5 ml/2 ml micro test tubes	22510070
Swing-bucket rotor A-4-62 (4 x 250 mL), with 4 rectangular buckets of 250 mL	22638009
1 rectangular bucket of 250 mL with weight category (for individual deliveries, please state the existing weight category)	22638025
2 aerosol-tight caps for 250 mL rectangular bucket	22638033
4 replacement seals for aerosol-tight caps	22638017

7 Ordering information

Adapters for standard test tubes, blood withdrawal symptoms and micro test tubes for 250 mL rectangular bucket (Number and diameter of bores)

2 adapters for 1.5 – 5 mL test tubes (25 x 11)	22638203
2 adapters for 1.5 – 2 mL micro test tubes (16 x 11)	22638220
2 adapters for 4 – 7 mL test tubes (15 x 13)	22638246
2 adapters for 3 – 15 mL test tubes (12 x 16)	22638262
2 adapters for 7 – 17 mL test tubes (12 x 17.5)	22638301
2 adapters for 7 – 18 mL test tubes (8 x 20)	22638327
2 adapters for 18 – 30 mL test tubes (4 x 26)	22638360
2 adapters for 30 – 50 mL test tubes (4 x 31)	22638386
2 adapters for 50 – 75 mL test tubes (2 x 35)	22638408
2 adapters for 80 – 120 mL test tubes (1 x 46)	22638424
2 adapters for 160 – 250 mL test tubes (1 x 62)	22638441
4 spare rubber mats	22638483
4 spare rubber mats for adapter 22638441	22638459
2 spare clamps	22628467

Adapters for Falcon® test tubes for 250 mL rectangular bucket (Number and diameter of bores)

2 adapters for 15 mL Falcon® test tubes (9 x 17.5)	22638289
2 adapters for 50 mL Falcon® test tubes (3 x 31)	22638343
2 adapters for 50 mL Falcon® -test tubes (4 x 31)	22638351

Swing bucket rotor 4 x 100 mL, type A-4-44, see 5804 / 5804 R and brochure

Swing-bucket rotor A-4-62-MTP, with 4 plate carriers 22638041

4 plate carriers for swing-bucket rotor, A-4-62-MTP, for 4 plates or 1 deepwell plate 22638068

1 plate carriers for swing-bucket rotor, A-4-62-MTP with weight category (individual delivery only as a replacement delivery with prior agreement) 22638076

Deepwell plate rotor A-2 DWP with 2 DWP buckets for deepwell plates 22638564

Deepwell plate bucket with weight category for swing-bucket rotor A-2-DWP (individual delivery only as a replacement delivery with prior agreement) 22638572

Fixed-angle rotors and accessories: see 5804 / 5804 R and brochure

Drum rotor and accessories: see 5804 / 5804 R and brochure

Accessories for the Centrifuges 5810 / 5810 R

Grease for pivots	22634330
Standard rotor key	22664166
Conversion kit for interface for 5810	Upon request
Conversion kit for interface for 5810 R	Upon request
Tray for condensation water	22662678

Important note:

Please use the original accessories recommended by Eppendorf. Using spare parts or disposables which we have not recommended can reduce the precision, accuracy and life of the centrifuges.

We do not honor any warranty or accept any responsibility for damage resulting from such action.

Eppendorf Offices

ASEAN

Eppendorf AG
Regional Office in Malaysia
Tel. +60 3 8023 2769
Fax +60 3 8023 3720
E-Mail: eppendorf@eppendorf.com.my
Internet: www.eppendorf.com.my

AUSTRALIA / NEW ZEALAND

Eppendorf South Pacific Pty. Ltd.
Tel. +61 2 9889 5000
Fax +61 2 9889 5111
E-mail: Info@eppendorf.com.au
Internet: www.eppendorf.com.au

AUSTRIA

Eppendorf AG
c/o Schott Austria
Tel. +43 1 29017560
Fax +43 1 290175620
E-Mail: gilch.p@eppendorf.de
Internet: www.eppendorf.com

BRAZIL

Eppendorf do Brasil Ltda.
Tel. +55 11 30 95 93 44
Fax +55 11 30 95 93 40
E-Mail: eppendorf@eppendorf.com.br
Internet: www.eppendorf.com.br

CANADA

Brinkmann Instruments, Ltd.
Tel. +1 905 826 5525
Fax +1 905 826 5424
E-Mail: canada@brinkmann.com
Internet: www.brinkmann.com

CHINA

Eppendorf AG
Tel. +86 21 68760880
Fax +86 21 50815371
E-Mail: market.info@eppendorf.cn
Internet: www.eppendorf.cn

FRANCE

EPPENDORF FRANCE S.A.R.L.
Tel. +33 1 30 15 67 40
Fax +33 1 30 15 67 45
E-Mail: eppendorf@eppendorf.fr
Internet: www.eppendorf.fr

GERMANY

Eppendorf Vertrieb
Deutschland GmbH
Tel. +49 2232 418-0
Fax +49 2232 418-155
E-Mail: vertrieb@eppendorf.de
Internet: www.eppendorf.de

INDIA

Eppendorf India Limited
Tel. +91 44 52111314
Fax +91 44 52187405
E-Mail: info@eppendorf.co.in
Internet: www.eppendorf.co.in

ITALY

Eppendorf s.r.l.
Tel. +390 2 55 404 1
Fax +390 2 58 013 438
E-Mail: eppendorf@eppendorf.it
Internet: www.eppendorf.it

JAPAN

Eppendorf Japan Co. Ltd.
Tel. +81 3 5825 2363
Fax +81 3 5825 2365
E-Mail: info@eppendorf.jp
Internet: www.eppendorf.jp

NORDIC

Eppendorf Nordic Aps
Tel. +45 70 22 2970
Fax +45 45 76 7370
E-Mail: nordic@eppendorf.dk
Internet: www.eppendorf.dk

SPAIN

Eppendorf Ibérica S.L.
Tel. +34 91 651 76 94
Fax +34 91 651 81 44
E-Mail: iberica@eppendorf.de
Internet: www.eppendorf.es

SWITZERLAND

Vaudaux-Eppendorf AG
Tel. +41 61 482 1414
Fax +41 61 482 1419
E-Mail: vaudaux@vaudaux.ch
Internet: www.eppendorf.com

UNITED KINGDOM

Eppendorf UK Limited
Tel. +44 1223 200 440
Fax +44 1223 200 441
E-Mail: sales@eppendorf.co.uk
Internet: www.eppendorf.co.uk

USA

Eppendorf North America
Tel. +1 516 334 7500
Fax +1 516 334 7506
E-Mail: info@eppendorf.com
Internet: www.eppendorfna.com

OTHER COUNTRIES

see:
www.eppendorf.com/worldwide

eppendorf

In touch with life

Your local distributor: www.eppendorf.com/worldwide

Eppendorf AG · 22331 Hamburg · Germany · Tel. +49 40 538 01-0 · Fax +49 40 538 01-556 · E-Mail: eppendorf@eppendorf.com

Eppendorf North America, Inc. · One Cantiague Road, P.O. Box 1019 · Westbury, N.Y. 11590-0207 USA
Tel. +1 516 334 7500 · Toll free phone 800 645 3050 · Fax +1 516 334 7506 · E-Mail: info@eppendorf.com

Application Support

Europe, International: Tel. +49 1803 666 789 · E-Mail: support@eppendorf.com
North America: Tel. 800 645 3050 ext. 2258 · E-Mail: support_NA@eppendorf.com
Asia, Pacific: Tel. +603 8023 2769 · E-Mail: support_Asia@eppendorf.com